

Electrical Characteristic Curve

Line Regulation

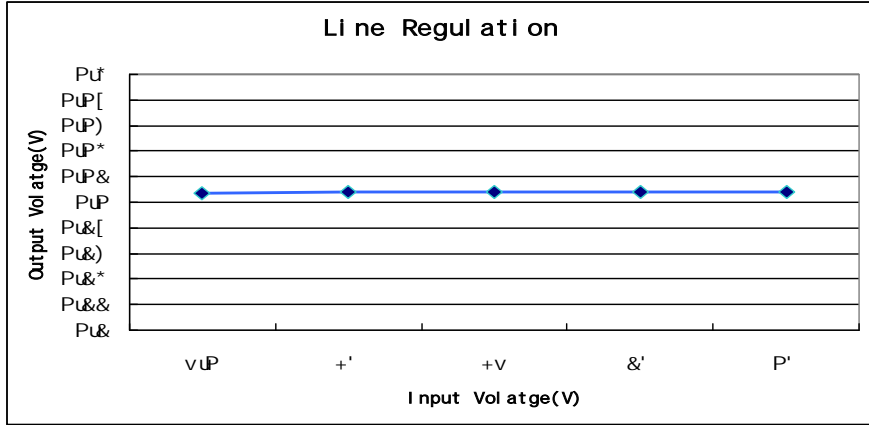

Load Regulation

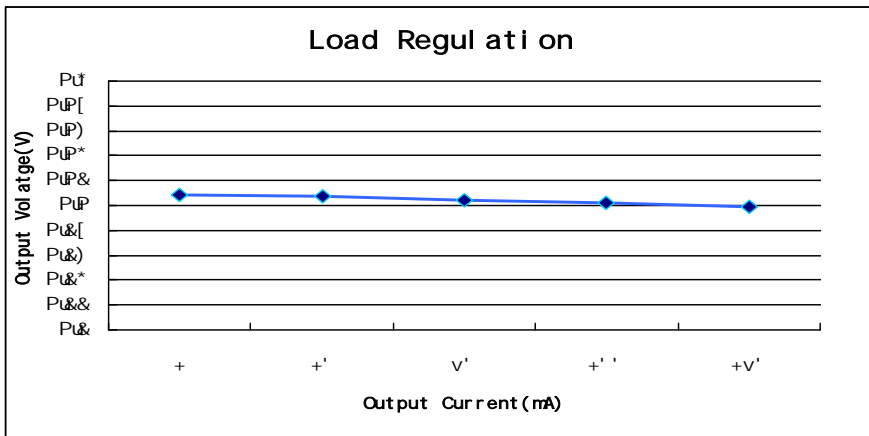

Temperature Drift

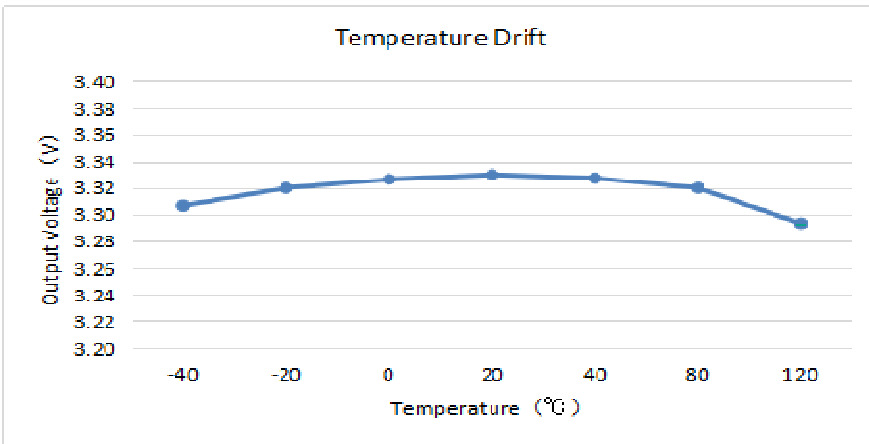

Line Regulation

BRC07533T

DATA SHEET

Typical Application Circuit

Figure 1: Typical Application Circuit

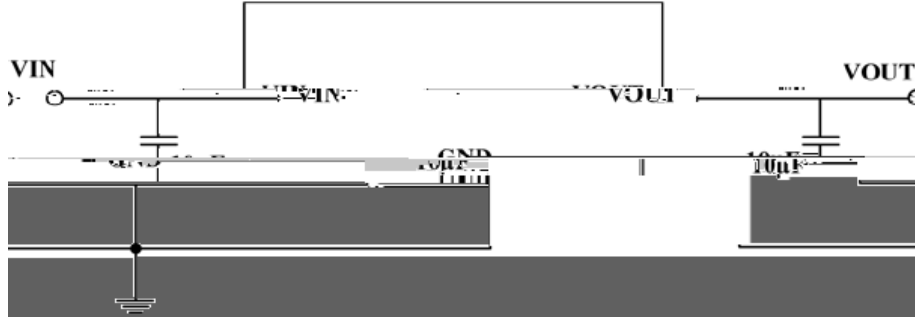

Figure 2: Typical Application Circuit

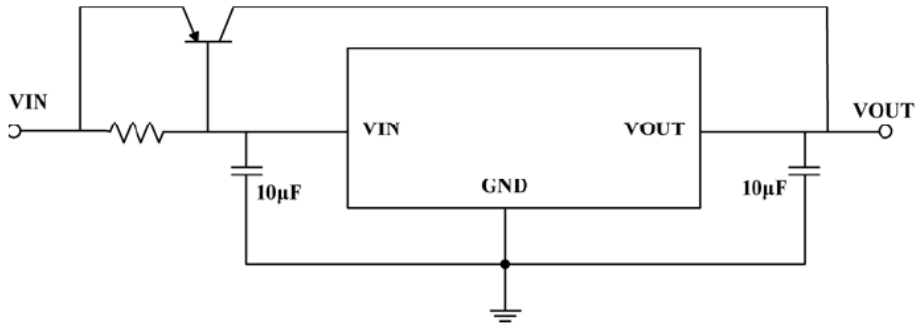
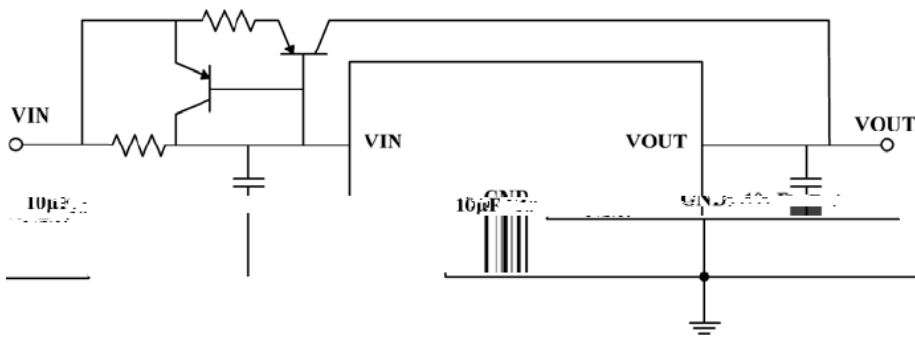

Figure 3: Typical Application Circuit



À

/ Marking Instructions

À
À
À
À
À
À
À
À
À
À
À
À
À
À
À
À
À
À
À
À
À
À

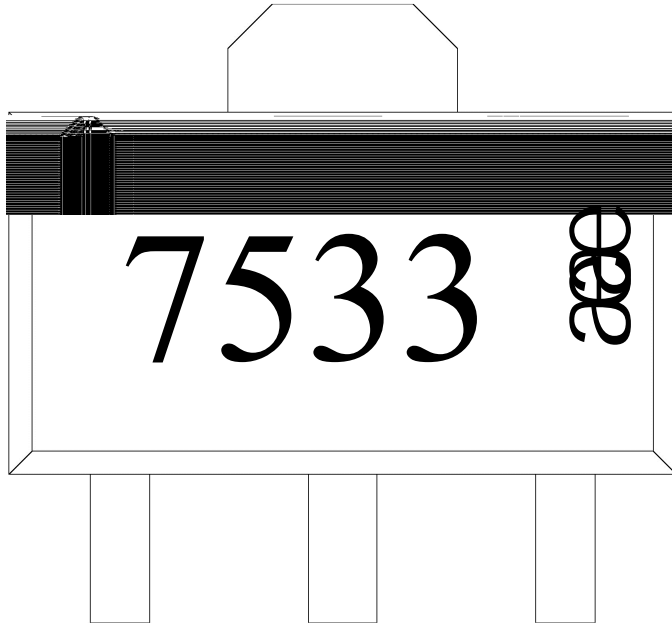

” · y À
‘QŌŌy À T Ō ~ à fl À
æy ‘ ‘ T ç { è ~ à fl < é ç { è ~ é è f ‘
PIÉ/ÉÀ
‘QŌŌÉÀ ÔBI ï ì HÉÀORĀ/ÉÀ
ààÈÀ À Î I ÉÀPIĀĀŠ I ÎÆŌÀHI ÎÆÀHÉLLMÆÀĐKÉĀ Î I ÉÀPIĀĀ

À

