

/ Descriptions

/ Features

/ Applications

/ Equivalent Circuit or Application Circuit

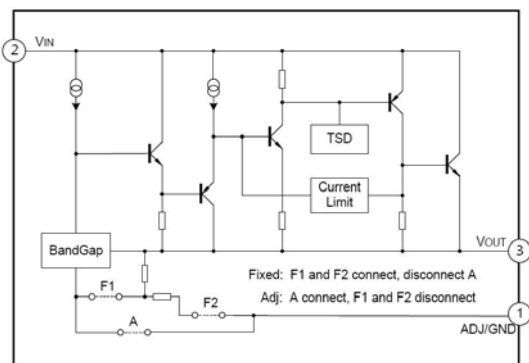

/ Pinning

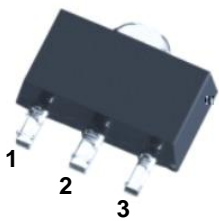

/ Marking

LD1117RT



DATA SHEET

--	--	--	--



/ Electrical Characteristics(Ta=25)

/ Typical Application Circuit



图 1. 典型固定输出电压



图 2. 典型可调输出电压

图 2

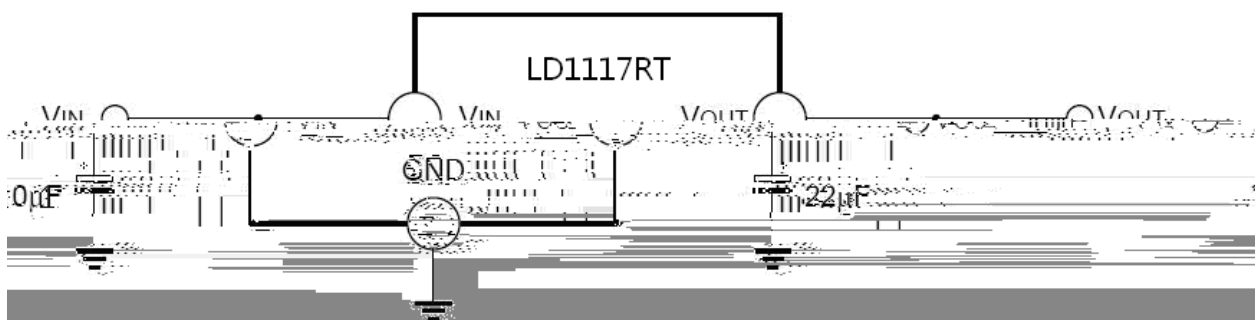
/ Electrical Characteristic Curve

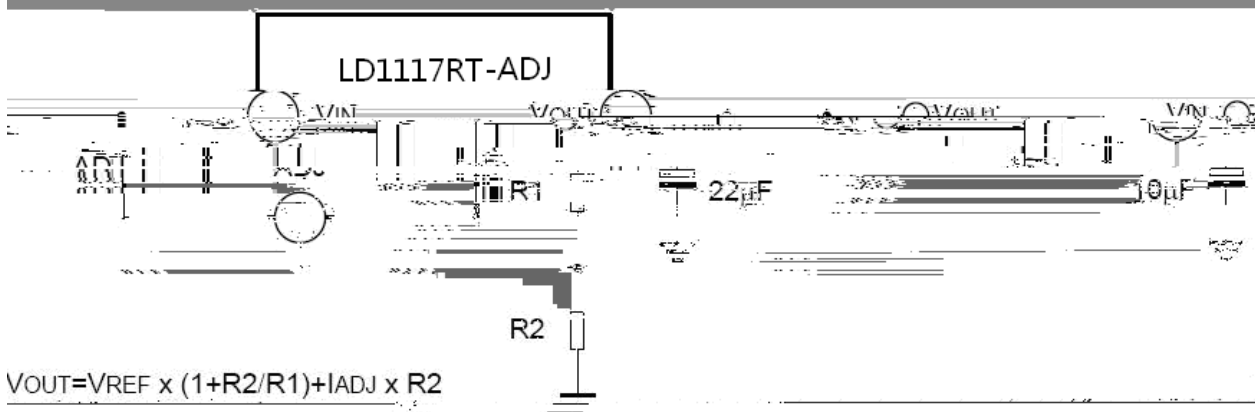
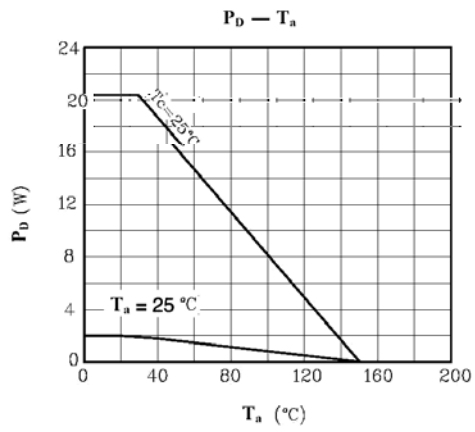
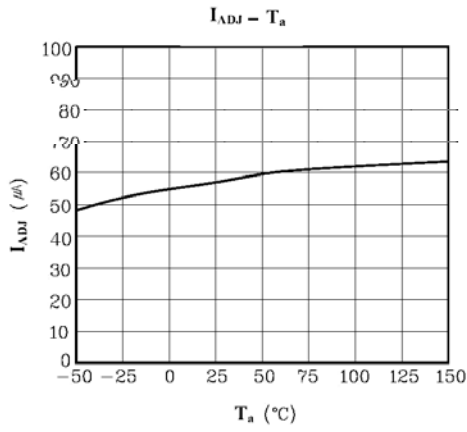
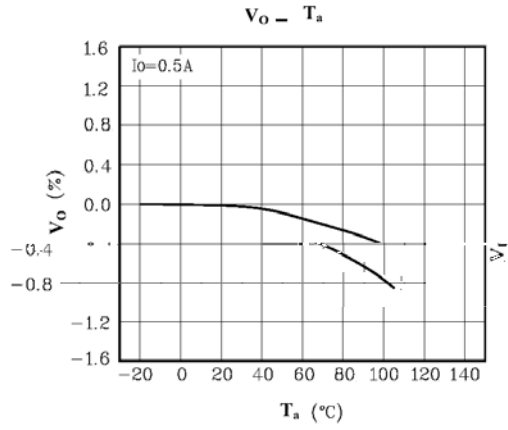
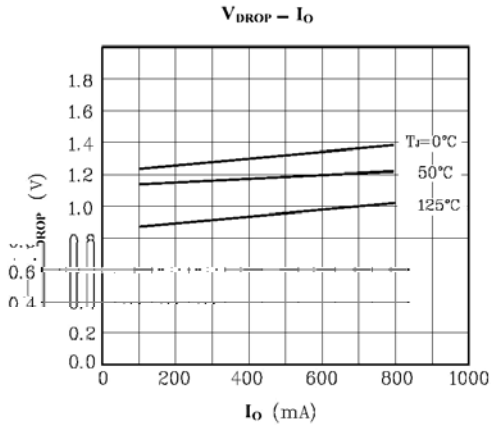

/ Package Dimensions

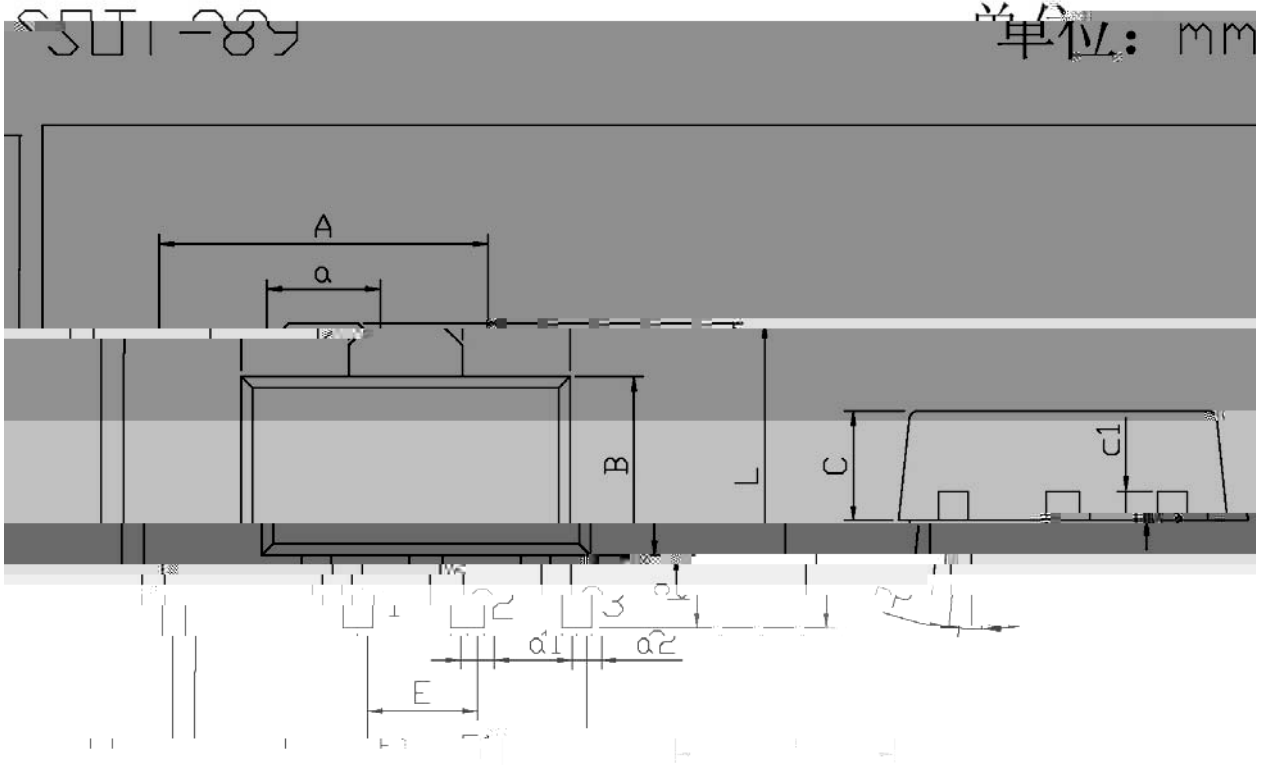

Dimensions in Millimeters	
Symbol	Maximum
A	4.4
a	2.5

Dimensions in Millimeters	
Symbol	Maximum
A	4.4
B	2.5



() / Temperature Profile for IR Reflow Soldering(Pb-Free)

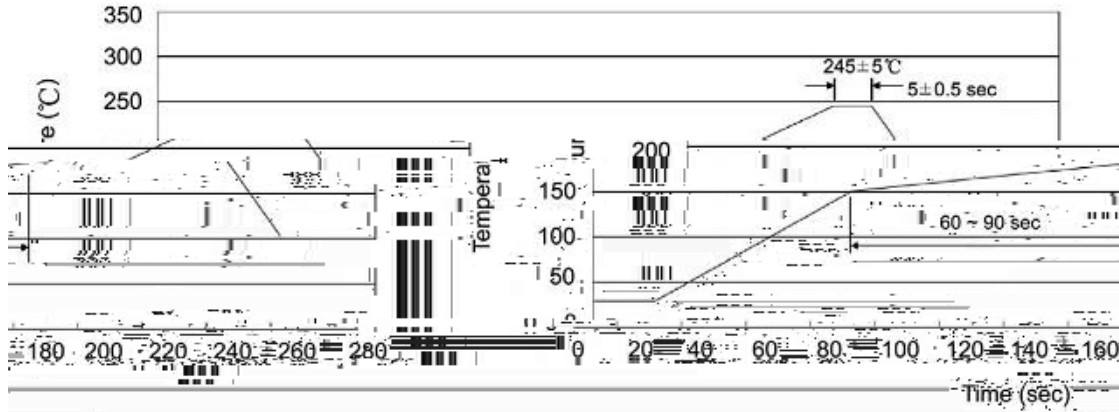

± ± ± ±

/ Resistance to Soldering Heat Test Conditions

± ±

/ Packaging SPEC.

	Units/Reel	Reels/Inner Box	Units/Inner Box	Inner Boxes/Outer Box	Units/Outer Box	Reel	Inner Box	Outer Box
	1,000	7	7,000	6	42,000			

/ Notices